

# Proportional pressure reducing valve, pilot operated

## Type DRE(M) and DRE(M)E

**RE 29278**

Edition: 2012-12

Replaces: 11.11



- ▶ Size 32
- ▶ Component series 6X
- ▶ Maximum operating pressure 315 bar
- ▶ Maximum flow: 300 l/min

### Features

- ▶ Valve for reducing an operating pressure
- ▶ Operation by means of proportional solenoid
- ▶ Proportional solenoid with rotatable and detachable coil
- ▶ For subplate mounting:
  - Porting pattern according to ISO 5781
- ▶ Optional check valve between A and B
- ▶ Maximum pressure limitation optional
- ▶ Valve and control electronics from a single source
- ▶ Integrated electronics (OBE) with type DREME:
  - Little manufacturing tolerance of the command value
  - pressure characteristic curve
- ▶ External control electronics with type DRE and DREM (separate order)

### Contents

Features	1
Ordering code	2, 3
Symbols	3
Function, section	4, 5
Technical data	6, 7
Electrical connection	8, 9
Integrated electronics (OBE)	9
Characteristic curves	10 ... 14
Device dimensions	15, 16
Accessories	16

**Ordering code**

01	02	03	04	05	06	07	08	09	10	11	12	13	14
<b>DRE</b>			<b>30</b>	<b>-</b>	<b>6X</b>	<b>/</b>		<b>Y</b>		<b>G24</b>			<b>*</b>

01	Proportional pressure reducing valve	<b>DRE</b>
02	<b>Without</b> maximum pressure limitation	<b>no code</b>
	<b>With</b> maximum pressure limitation	<b>M</b> <sup>1)</sup>
03	For external control electronics	<b>no code</b>
	With integrated electronics (OBE)	<b>E</b>

**Size**

04	Size 32	<b>30</b>
05	Component series 60 to 69 (60 to 69: Unchanged installation and connection dimensions)	<b>6X</b>

**Pressure rating**

06	Up to 50 bar	<b>50</b>
	Up to 100 bar	<b>100</b>
	Up to 200 bar	<b>200</b>
	Up to 315 bar	<b>315</b>
07	Pilot oil return always external, separately and at zero pressure to the tank	<b>Y</b>
08	<b>With</b> check valve between A and B	<b>no code</b>
	<b>Without</b> check valve	<b>M</b>

**Supply voltage**

09	24 V DC voltage	<b>G24</b>
10	1600 mA coil	<b>no code</b>
	800 mA coil	<b>-8</b> <sup>2)</sup>

<sup>1)</sup> The maximum pressure limitation only serves as protection against overpressure in case of an error in the pilot valve (e.g. in case of contamination or over-current).

<sup>2)</sup> Replacement for series 4X (Attention! External amplifiers only suitable for G24 = 1.6 A solenoid), see accessories.

### Ordering code

01	02	03	04	05	06	07	08	09	10	11	12	13	14
DRE			30	-	6X	/		Y		G24			*

### Electrical connection

11	<b>For type DBEM:</b>	
	Without mating connector; connector DIN EN 175301-803	K4 <sup>3)</sup>
	<b>For type DBEME:</b>	
	Without mating connector; connector DIN EN 175201-804	K31 <sup>3)</sup>

### Electronics interface

12	Command value 0 to 10 V	A1
	Command value 4 to 20 mA	F1
	With DBEM	no code

### Seal material

13	NBR seals	M
	FKM seals	V
	Attention: Observe compatibility of seals with hydraulic fluid used!	

14	Further details in the plain text	
----	-----------------------------------	--

<sup>3)</sup> Mating connectors, separate order, see page 8 and 16

### Symbols

For external control electronics:

DRE 30-6X/...YM...

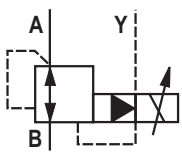

DREM 30-6X/...YM...

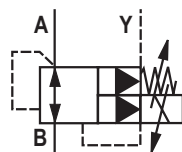

DRE 30-6X/...Y...

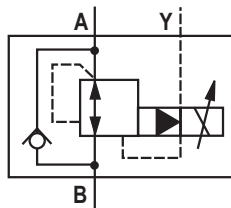

DREM 30-6X/...Y...

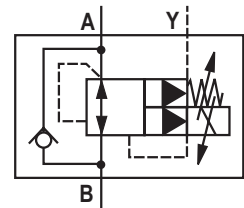

With integrated electronics:

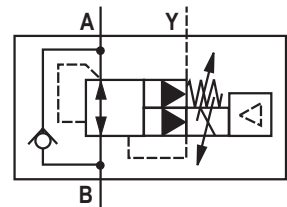
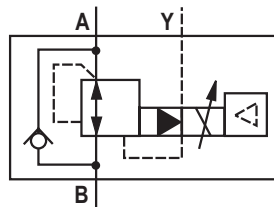
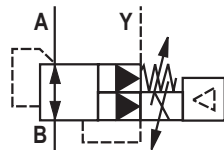
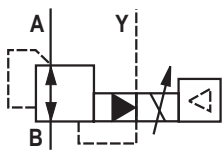

DREE 30-6X/...YM...

DREME 30-6X/...YM...

DREE 30-6X/...Y...

DREME 30-6X/...Y...

## Function, section

Valves of type DRE(M) are pilot operated pressure reducing valves. They are used to reduce an operating pressure.

These valves basically consist of a pilot control valve (1) with proportional solenoid (2), a main valve (3) with main spool insert (4), as well as an optional check valve (5).

### Type DRE...

The pressure in channel A is set in a command value-dependent form via the proportional solenoid (2).

In rest position – no pressure in channel B –, the spring (11) holds the main spool (4) in its initial position. The connection from channel B to A is open.

The pressure in channel A acts on the bottom side of the main spool in closing direction and the pressure of the pilot control valve on the spring side of the main spool in the opening direction from channel B to A.

The pilot oil is taken from channel B and flows via the bore (6) to the fixed flow control (9) keeping the pilot flow constant, independent of the pressure drop between channel A and B. From the fixed flow control (9), the pilot flow flows through the bores (7) via the valve seat (10) by the valve poppet (8) into the Y channel to the tank.

The pressure required in channel A is preset at the related amplifier. The proportional solenoid pushes the valve poppet (8) in the direction of the valve seat (10) and limits the pressure in the spring chamber (12) to the set value. In the control position of the main spool (4), the hydraulic fluid flows from channel B to A and generates the pressure in channel A (setting of the pilot control valve plus spring (11)). If the set pressure in A is achieved, the forces at the main spool are balanced.

When the actuator connected to port A is not moving (e.g. cylinder piston at stop), and a lower pressure is set in channel A via the proportional solenoid (2), the main spool (4) closes the connection from B to A and at the same time opens the connection from channel A to the spring chamber (12) of the main spool (4). In this position, the compression volume in channel A can expand via the pilot control valve (1) and port Y.

For the free flow back from channel A to B, a check valve (5) can optionally be installed.

A pressure gauge connection (13) allows for the control of the reduced pressure in channel A.

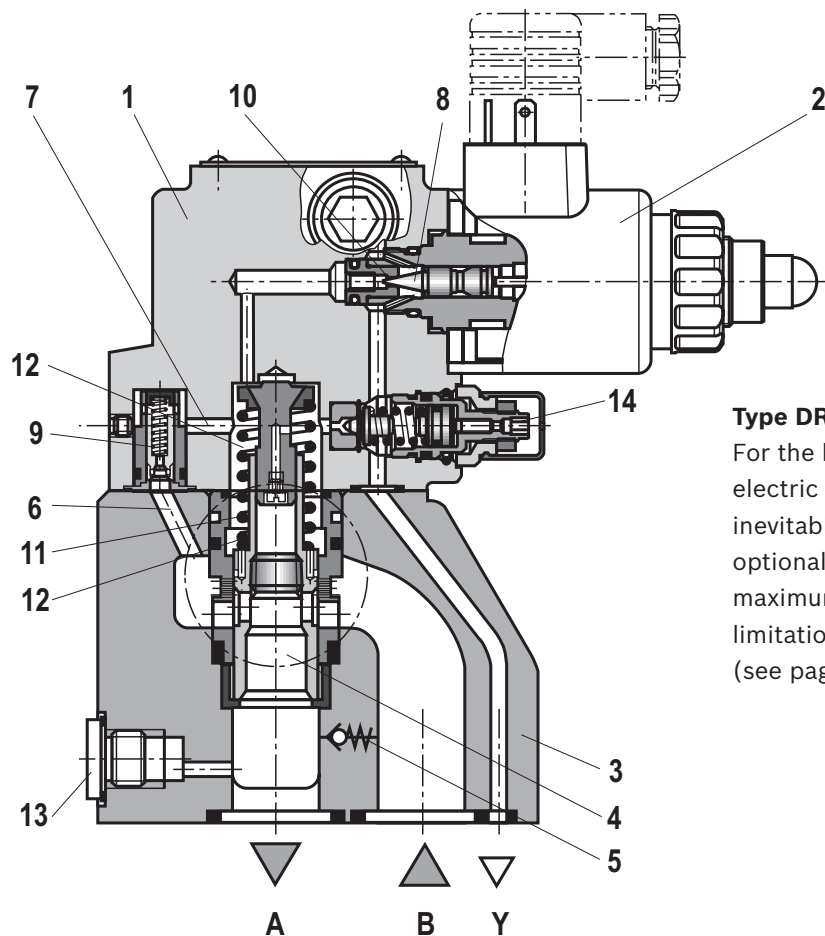

### Type DREM...

For the hydraulic protection against an inadmissible high electric control current at the proportional solenoid which inevitably results in excessive pressures in port A, you can optionally install a spring-loaded pressure relief valve as maximum pressure limitation (14). The maximum pressure limitation is pre-set, referred to the relevant pressure rating (see page 6).

**Type DREM.30-4X/.YG24K4...** (with check valve)

## Function, section

### Type **DRE(M)E** – with integrated electronics (OBE)

With regard to function and set-up, these types correspond to type DRE. On the proportional solenoid, there is moreover a housing (15) with the control electronics.

Supply and command value voltage are applied to the connector (16).

In the factory, the command value pressure characteristic curve is adjusted with little manufacturing tolerance.

For more information on the control electronics, see page 9.

### Type **DRE(M)E...-6X/...YG24K31...**

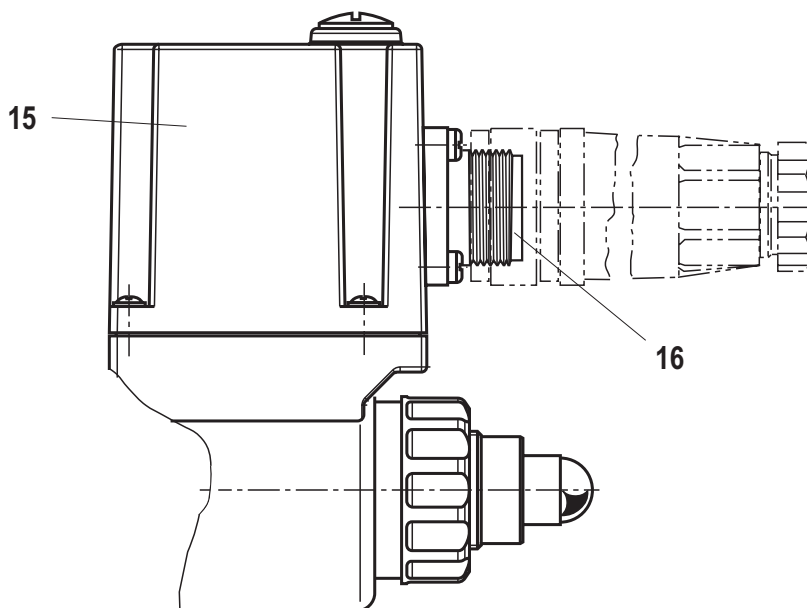

**Technical data**

(For applications outside these parameters, please consult us!)

<b>general</b>				
Weight	- Type DRE and DREM	kg	8.6	
	- Type DREE and DREME	kg	8.7	
Installation position			Any	
Storage temperature range		°C	-20 to +80	
Ambient temperature range	- Type DRE and DREM	°C	-20 to +70	
	- Type DREE and DREME	°C	-20 to +50	
<b>hydraulic</b> (measured with HLP46, $\vartheta_{oil} = 40 \pm 5 \text{ °C}$ )				
Maximum operating pressure	- Port A and B	bar	315	
	- Port Y	bar	Separately and to the tank at zero pressure	
Maximum set pressure in channel A	- Pressure rating 50 bar	bar	50	
	- Pressure rating 100 bar	bar	100	
	- Pressure rating 200 bar	bar	200	
	- Pressure rating 315 bar	bar	315	
Minimum set pressure in channel A with command value zero		bar	See characteristic curve page 14	
Maximum pressure limitation, fixedly set:			Set in the factory:	
	- Pressure rating 50 bar	bar	To 75 bar	
	- Pressure rating 100 bar	bar	To 130 bar	
	- Pressure rating 200 bar	bar	To 230 bar	
	- Pressure rating 315 bar	bar	To 350 bar	
Maximum flow of the main valve		l/min	300	
Pilot flow		l/min	1.0	
Hydraulic fluid			See table page 7	
Hydraulic fluid temperature range		°C	-20 to +70	
Viscosity range		mm <sup>2</sup> /s	15 to 380	
Maximum admissible degree of contamination of the hydraulic fluid - cleanliness class according to ISO 4406 (c)			Class 20/18/15 <sup>1)</sup>	
Hysteresis		%	±3 of the maximum set pressure <sup>2)</sup>	
Repetition accuracy		%	< ±2 of the maximum set pressure <sup>2)</sup>	
Linearity		%	±3.5 of the maximum set pressure <sup>2)</sup>	
Manufacturing tolerance of the command value pressure characteristic curve, related to the hysteresis characteristic curve; pressure increasing	- Type DRE(M)	%	±5 of the maximum set pressure <sup>2)</sup>	
	- Type DRE(M)E	%	±1.5 of the maximum set pressure	
Step response $T_u + T_g$	10 % → 90 %	ms	~160	Measured with standing hydraulic fluid column, 1 liter at port A
	90 % → 10 %	ms	~250	
Step response $T_u + T_g$	10 % → 90 %	ms	~250	Measured with standing hydraulic fluid column, 5 liters at port A
	90 % → 10 %	ms	~450	

<sup>1)</sup> The cleanliness classes specified for the components must be adhered to in hydraulic systems. Effective filtration prevents faults and at the same time increases the life cycle of the components. For the selection of the filters see [www.boschrexroth.com/filter](http://www.boschrexroth.com/filter).

<sup>2)</sup> Does not apply to types "G24-8"

**Technical data**

(For applications outside these parameters, please consult us!)

Hydraulic fluid	Classification	Suitable sealing materials	Standards
Mineral oils and related hydrocarbons	HL, HLP, HLPD, HLPP	NBR, FKM	DIN 51524
Flame-resistant	HFDU, HFDR	FKM	ISO 12922
– water-free			
– containing water	HFC Fuchs Hydrotherm 46M Petrofer Ultra Safe 620	NBR	ISO 12922

 **Important information on hydraulic fluids!**

► For more information and data on the use of other hydraulic fluids refer to data sheet 90220 or contact us!

► The flash point of the hydraulic fluid used must be 40 K higher than the maximum solenoid surface temperature.

► **Flame-resistant – containing water:** Maximum pressure differential 210 bar, otherwise, increased cavitation erosion. The pressure peaks should not exceed the maximum operating pressures! Life cycle as compared to HLP 30 to 100 % Fluid temperature maximum 60 °C

electric		G24	G24-8
Minimum solenoid current	mA	≤ 100	≤ 100
Maximum solenoid current	mA	1600 ±10 %	800 ±5 %
Solenoid coil resistance			
– Cold value at 20 °C	Ω	5.5	20.6
– Maximum hot value	Ω	8.05	33
Duty cycle	%	100	100

electrical, integrated electronics (OBE)			
Supply voltage			
– Nominal voltage	VDC	24	
– Lower limit	VDC	21	
– Upper limit	VDC	35	
Current consumption	A	≤ 1.5	
Required fuse protection	A	2, time-lag	
Inputs			
– Voltage	V	0 to 10	
– Current	mA	4 to 20	
Output			
– Actual current value	mV	1 mV ± 1 mA	
Protection class of the valve according to EN 60529		IP 65 with mating connector mounted and locked	

**Caution!**

At an ambient temperature of 70 °C and a duty cycle of 100 % with max. current, the coil of the 800 mA solenoid reaches temperatures of up to 170 °C. Contact with the coil may lead to burns.

### Electrical connection

(dimensions in mm)

#### Type DRE(M)

Connection at the connector

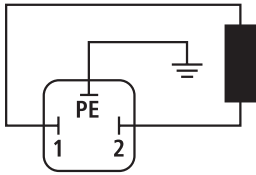

Connection at mating connector

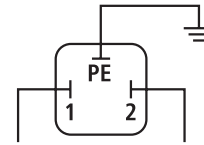

to the amplifier

Mating connector (black)  
according to DIN EN 175301-803  
Material no. **R901017011**  
(separate order)

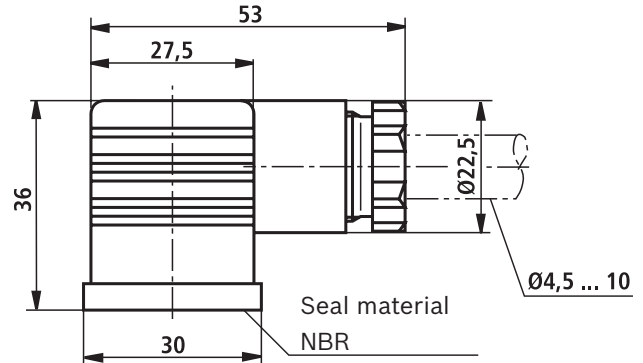
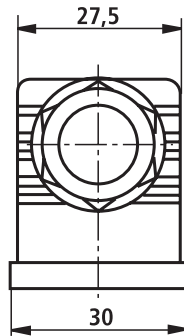

#### Type DRE(M)E

Device connector allocation	Contact	Allocation interface "A1"	Allocation interface "F1"
Supply voltage	A	24 VDC ( $u(t) = 21 \text{ V to } 35 \text{ V}$ ); $I_{\text{max}} \leq 1.5 \text{ A}$	
	B	0 V	
Reference potential actual value	C	Reference contact F; 0 V	Reference contact F; 0 V
Differential amplifier input	D	0 to 10 V; $R_E = 100 \text{ k}\Omega$	4 to 20 mA; $R_E = 100 \Omega$
	E	Reference potential command value	
Measuring output (actual value)	F	0 to 1.6 V actual value ( $1 \text{ mV} \triangleq 1 \text{ mA}$ ) Load resistance > 10 k $\Omega$	
Protective earth	PE	Connected to solenoid and valve housing	

Mating connectors according to DIN EN 175201-804, solder contacts for line cross-section 0.5 to 1.5 mm<sup>2</sup>

Plastic version,  
material no. **R900021267**  
(separate order)

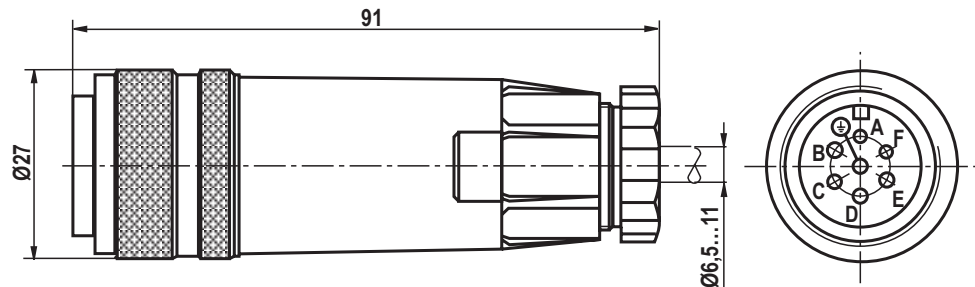

Metal version,  
material no. **R900223890**  
(separate order)

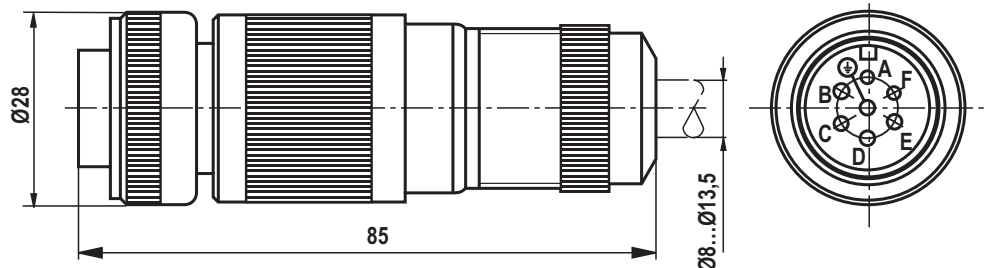



## Electrical connection

### Connection cable for type DRE(M)E

- Recommendation 6-wire, 0.75 or 1 mm<sup>2</sup> plus protective earthing conductor and screening
- Only connect the screening to PE on the supply side
- Maximum admissible length 100 m

The minimum supply voltage at the mains adapter depends on the length of the supply line (see diagram).

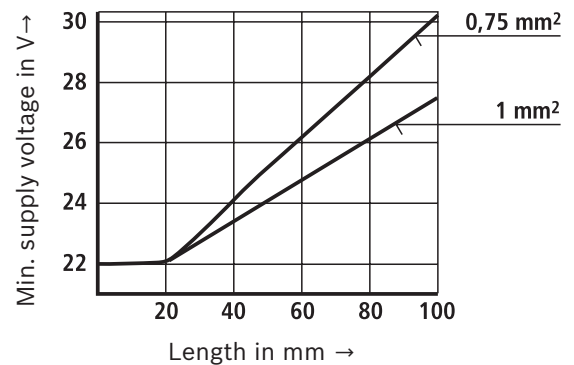

## Integrated electronics (OBE) with type DRE(M)E

### Function

The electronics are supplied with voltage via ports A and B. The command value is applied to the differential amplifier ports D and E.

Via the characteristic curve generator, the command value solenoid current characteristic curve is adjusted to the valve so that non-linearities in the hydraulics are compensated for and a linear command value pressure characteristic curve is created.

The current controller controls the solenoid current independent of the solenoid coil resistance.

The power stage of the electronics for controlling the proportional solenoid is a chopper amplifier with a cycle frequency of approx. 180 Hz to 400 Hz. The output signal is pulse-width modulated (PWM).

For checking the solenoid current, a voltage can be measured at the connector between pin F(+) and pin C(-) that is proportional to the solenoid current. **1 mV** corresponds to **1 mA** solenoid current.

### Block diagram

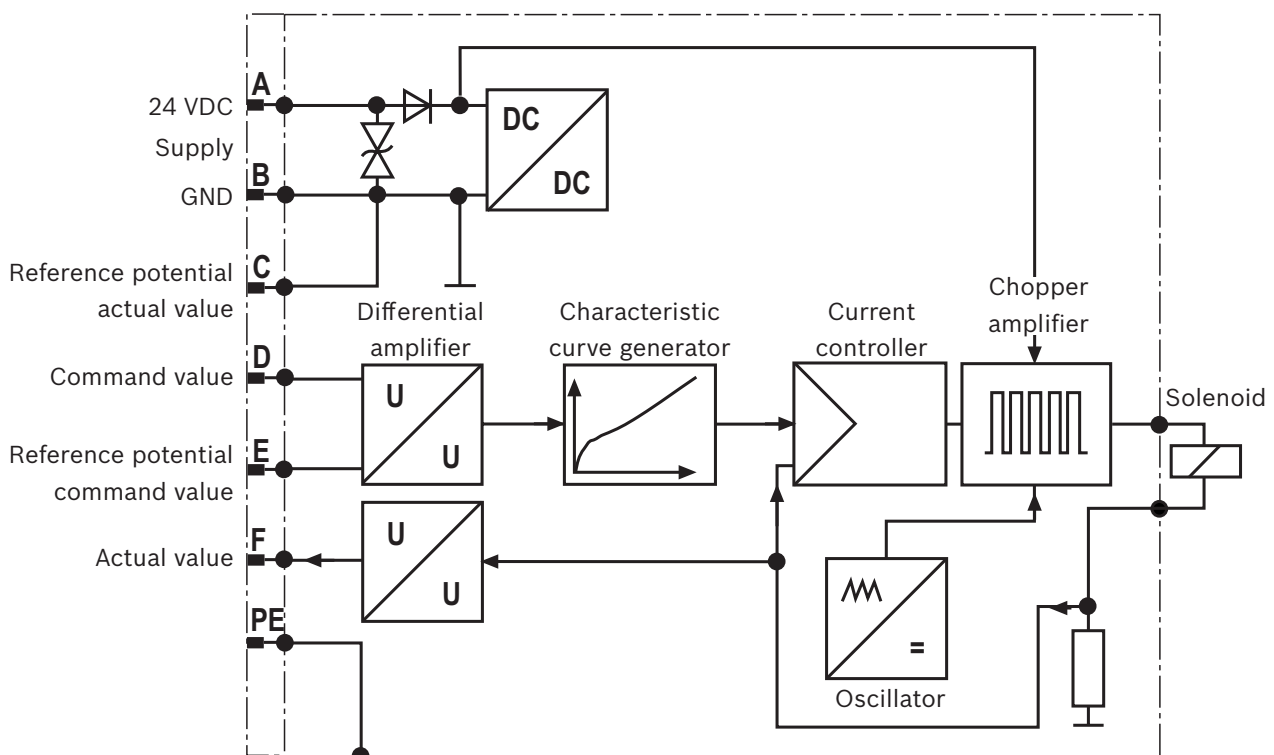

### Characteristic curves

(measured with HLP46,  $\vartheta_{oil} = 40 \pm 5 \text{ }^\circ\text{C}$ )

**Pressure in port P depending on the command value** (flow = 0.8 l/min)

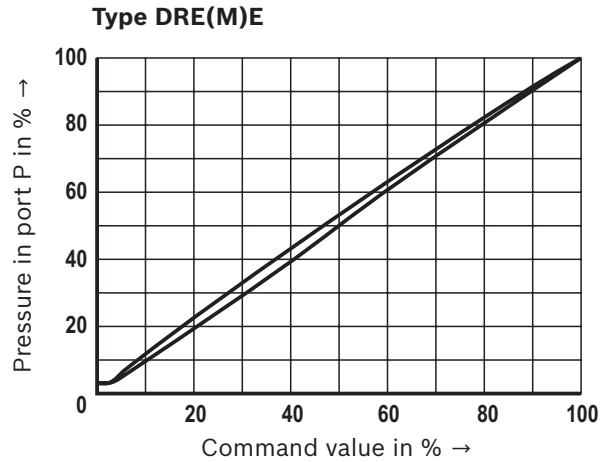
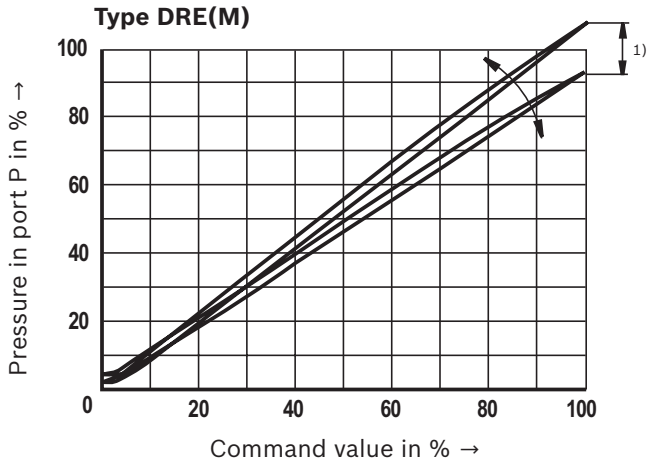

<sup>1)</sup> With valve type DRE(M), the manufacturing tolerance at the **external amplifier** (type and data sheet see page 16) can be changed using the command value attenuator potentiometer "Gw". The digital amplifier is set using the "Limit" parameter.

In this connection, the control current according to the technical data must not be exceeded.

In order to be able to adjust several valves to the same characteristic curve, do not set the pressure higher than the maximum set pressure of the pressure rating with command value 100 %.

**Pressure in channel A depending on command value** (measured with a flow of 0 l/min from B to A as well as related control electronics)

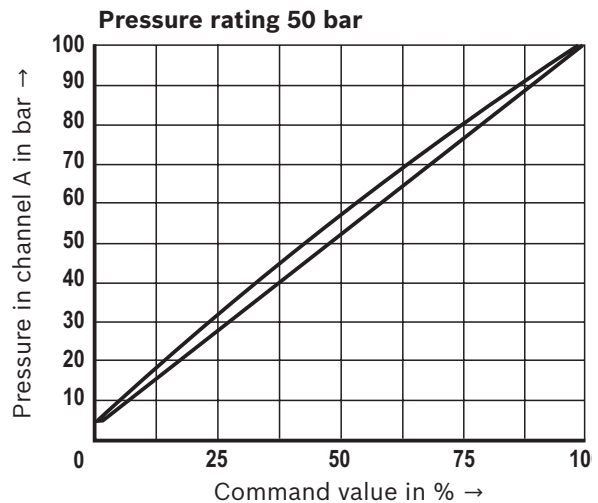
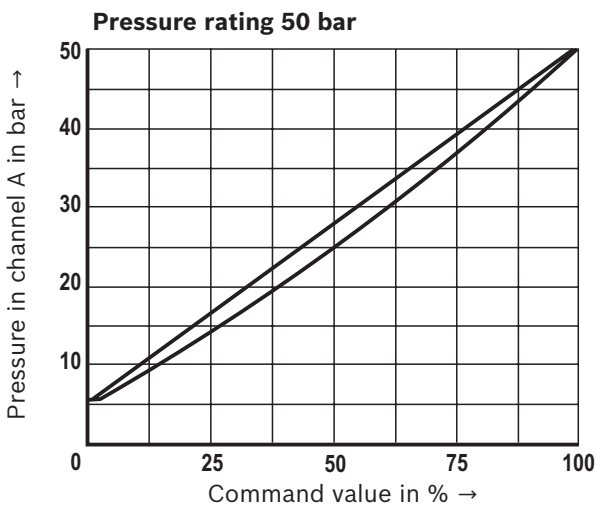

### Characteristic curves

(measured with HLP46,  $\vartheta_{oil} = 40 \pm 5 \text{ }^\circ\text{C}$ )

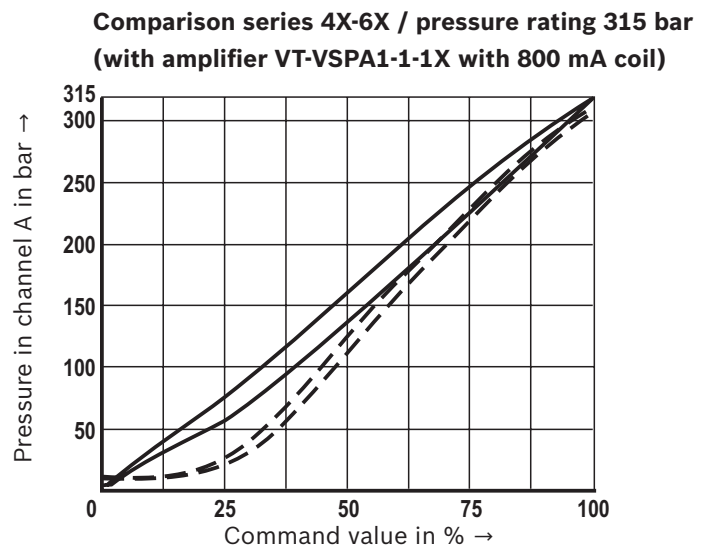
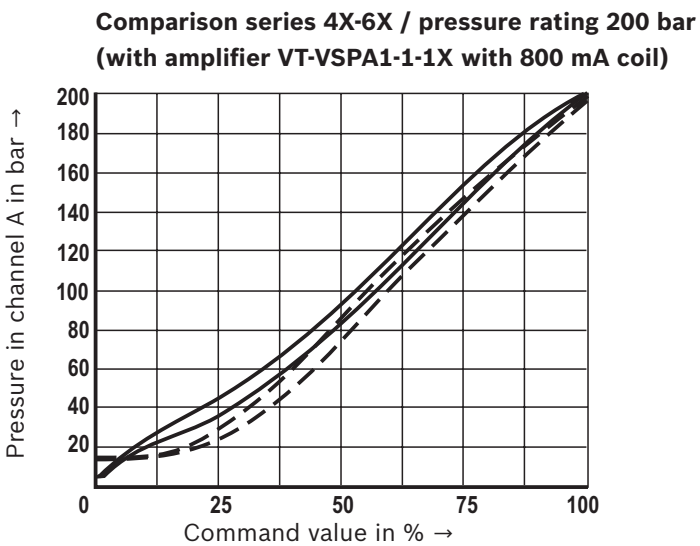
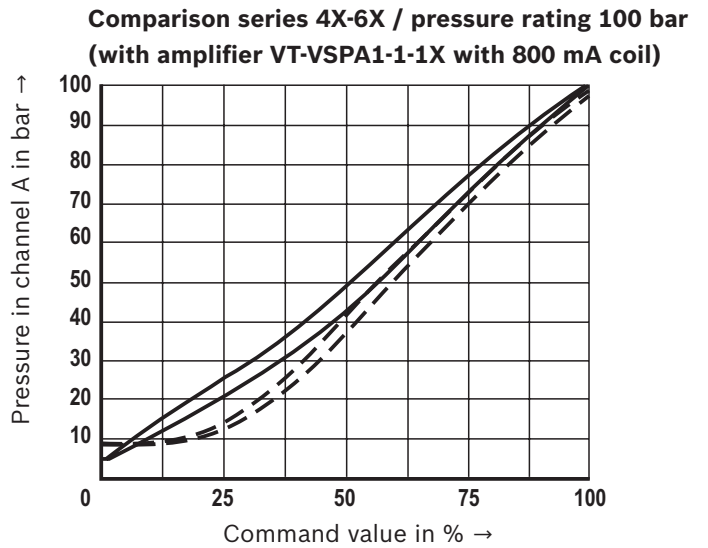
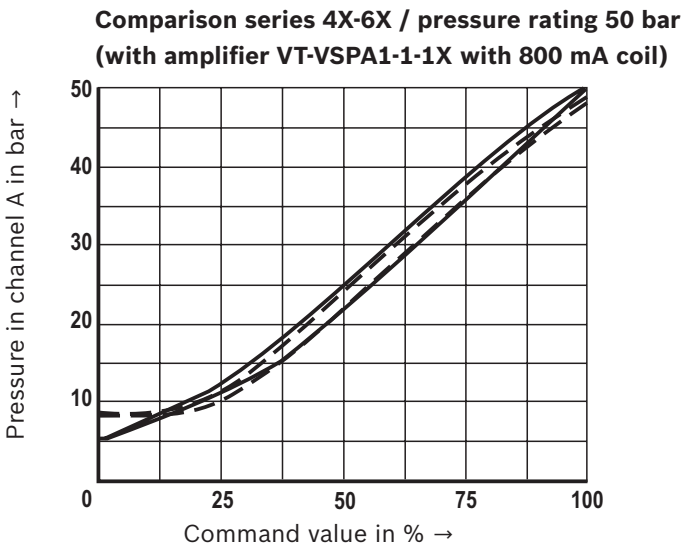
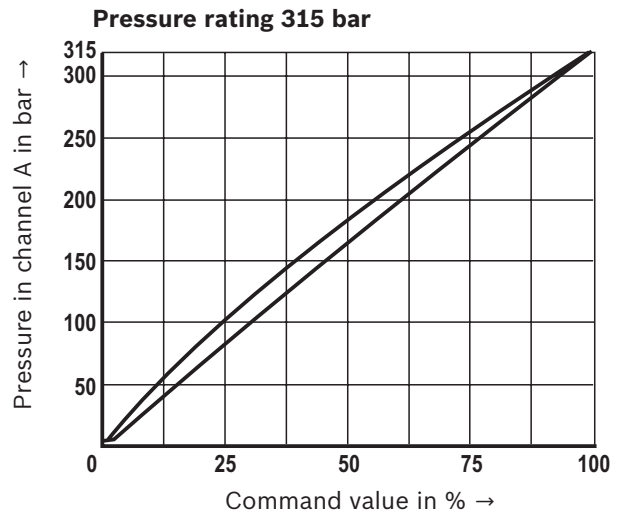
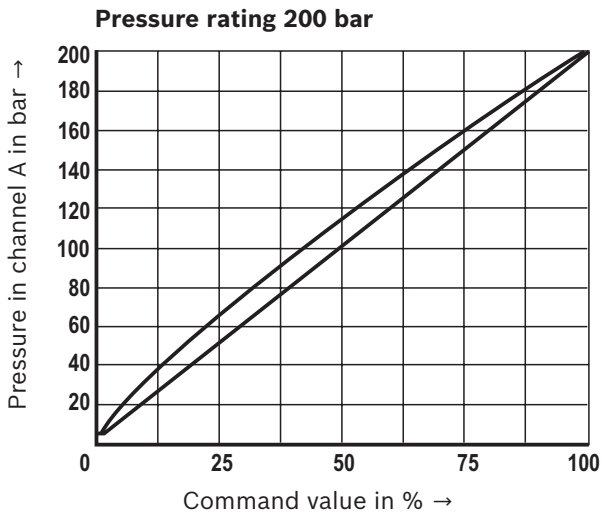

- Series 4X
- Series 6X 800 mA

**Notice!**

In order to achieve the lowest settable pressure, the pilot current must not exceed 100 mA.

### Characteristic curves

(measured with HLP46,  $\vartheta_{oil} = 40 \pm 5 \text{ }^\circ\text{C}$ )

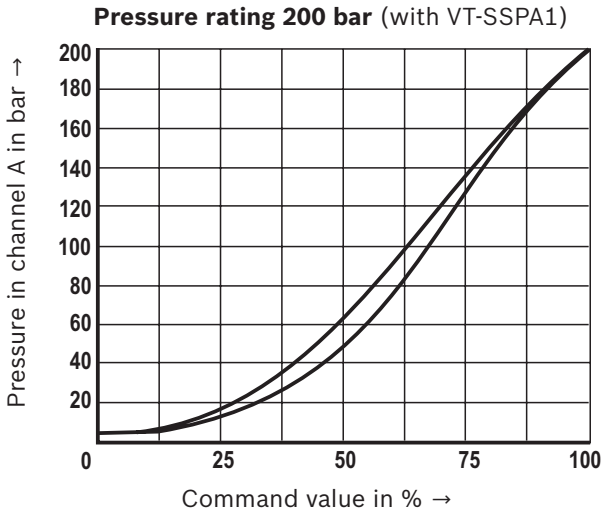

### Pressure in channel A dependent on the flow $Q_v$

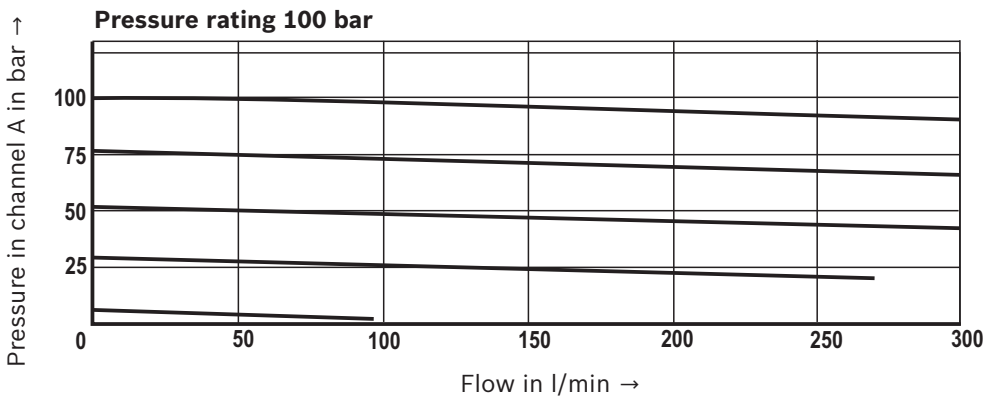
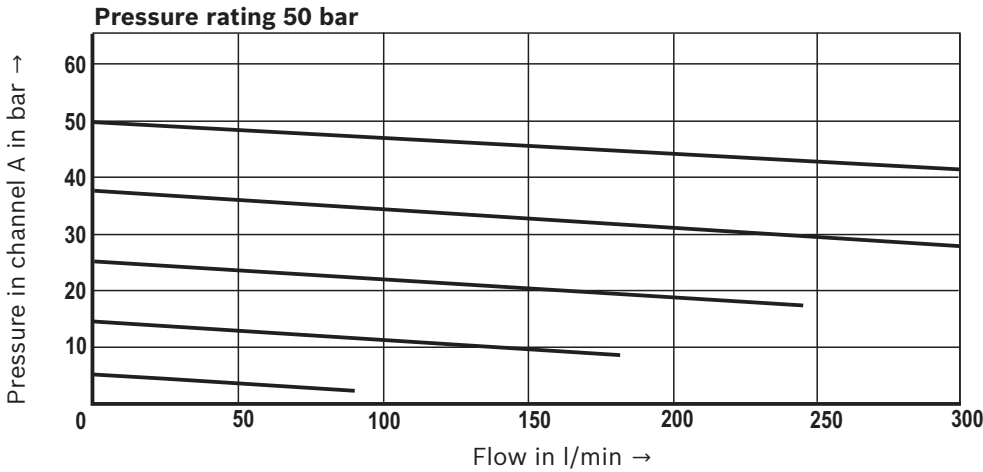

### Characteristic curves

(measured with HLP46,  $\vartheta_{oil} = 40 \pm 5 \text{ }^\circ\text{C}$ )

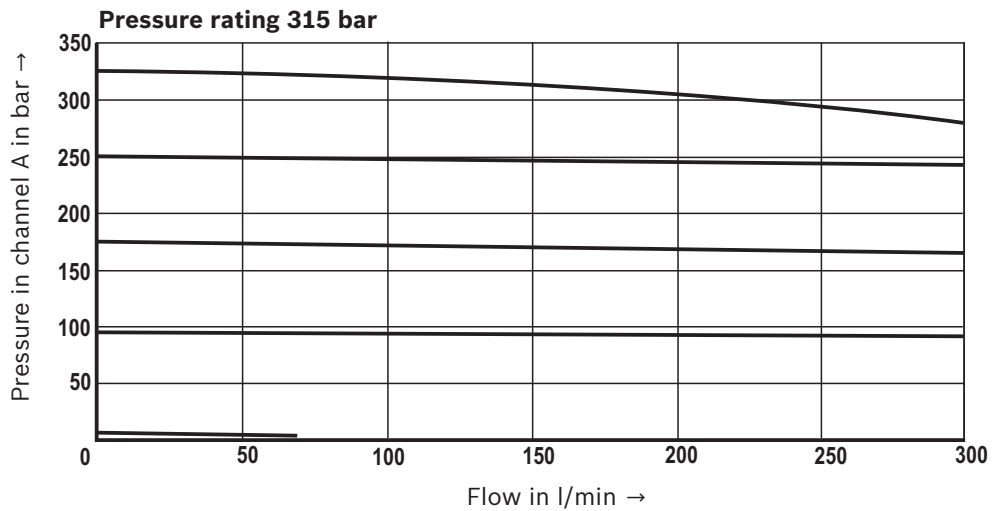
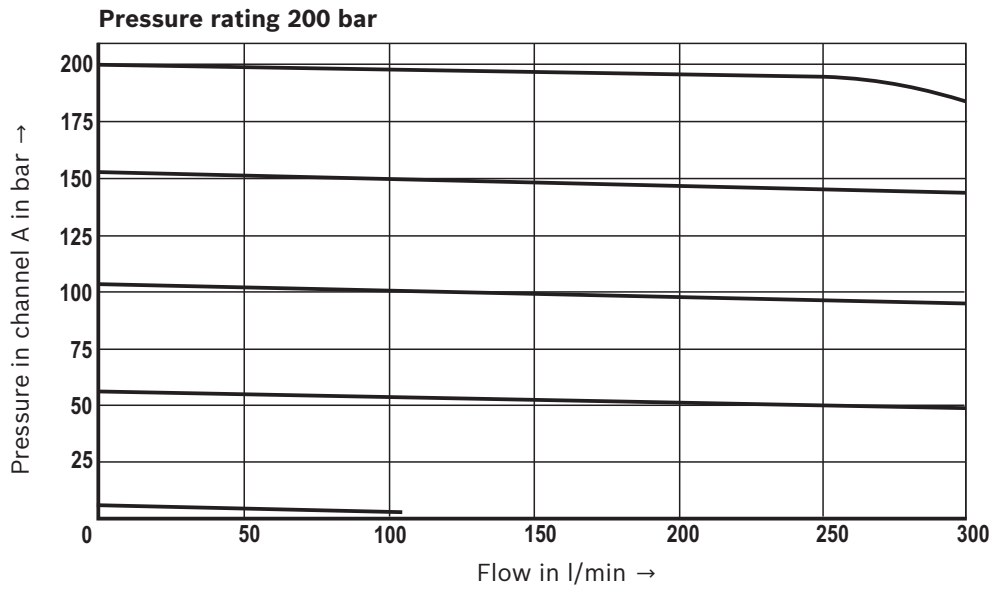

### Characteristic curves

(measured with HLP46,  $\vartheta_{oil} = 40 \pm 5 \text{ } ^\circ\text{C}$ )

#### Pressure in channel A depending on pressure in channel B

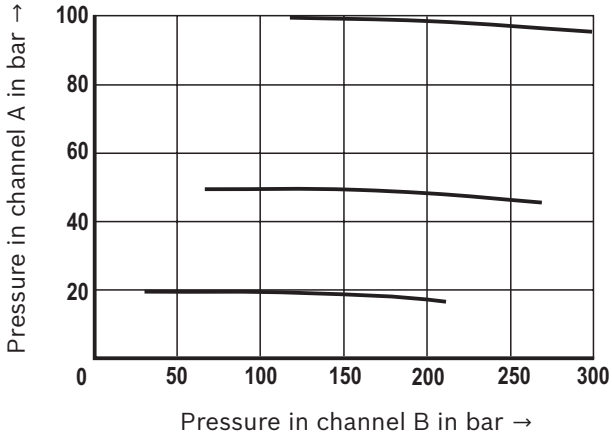

#### $p_{min}$ - $Q_v$ characteristic curve

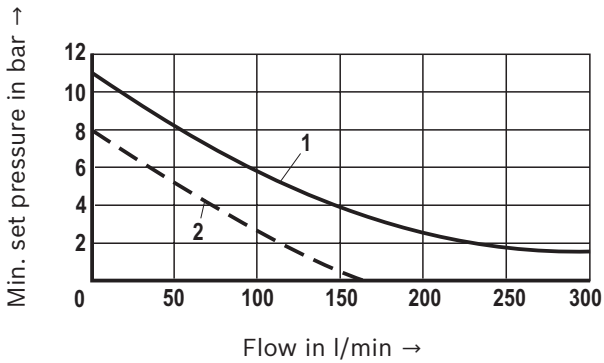

Characteristic curve 1: Same behavior of series 4X and 6X with  $p_{min} = 11$  bar

Characteristic curve 2: Series 6X improved  $p_{min} = 8$  bar, resulting in lower flow at  $p_{min}$

#### Pressure differential from A to B via the check valve

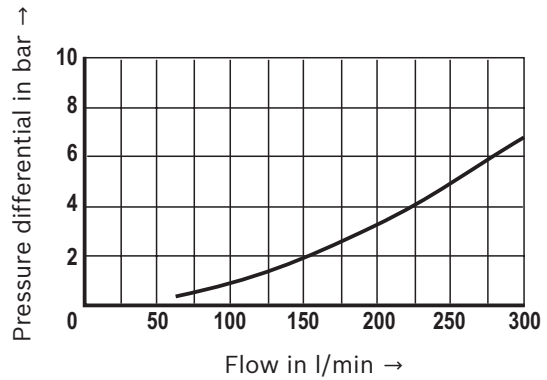

**Device dimensions**  
(dimensions in mm)

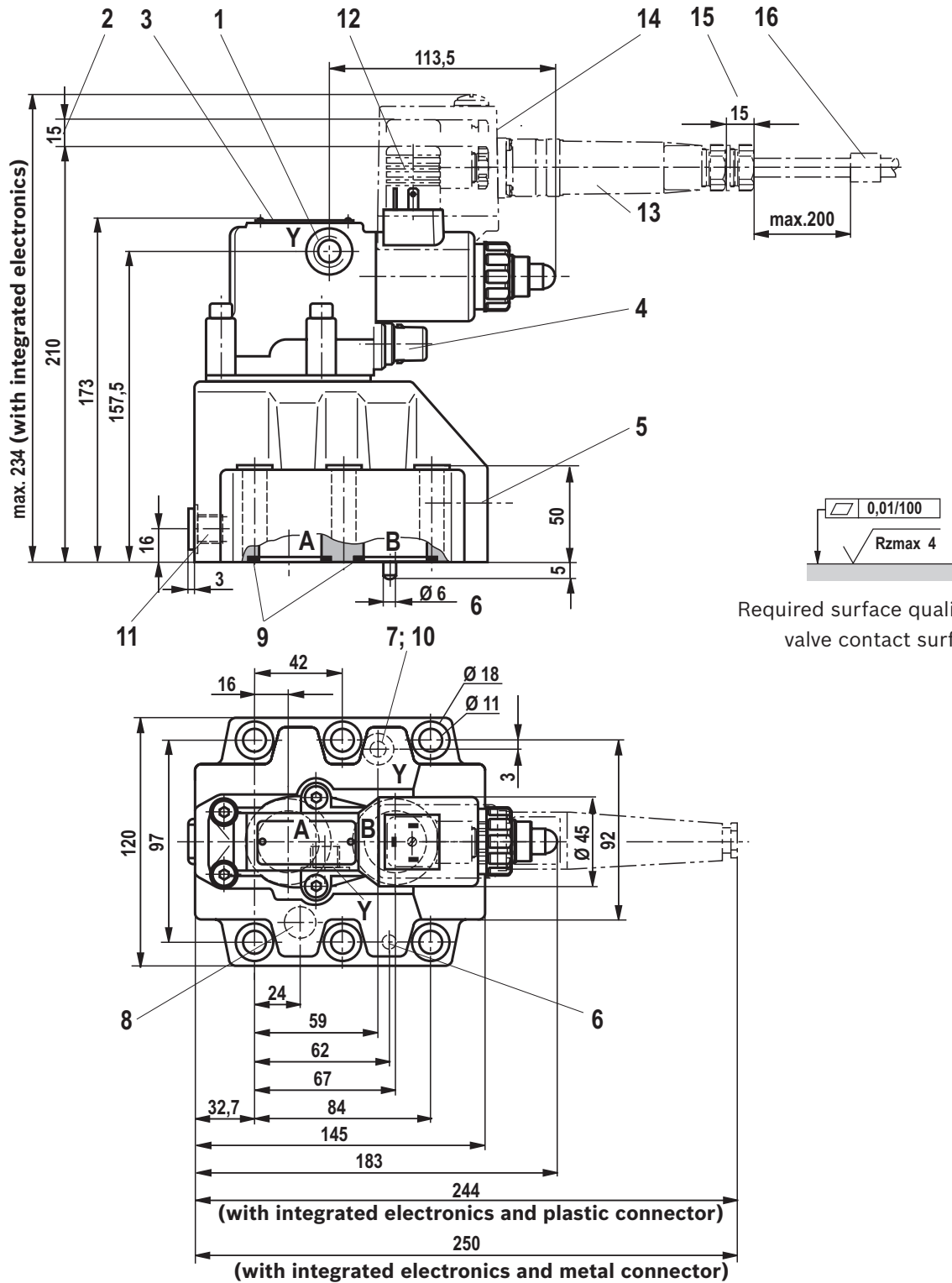

**Notice!**

The dimensions are nominal dimensions which are subject to tolerances.

Item explanations, valve mounting screws and subplates see page 16.

## Device dimensions

- |   |  |
|---|--|
| <ol style="list-style-type: none"> <li>1 Upon delivery, this port (G 1/4) is closed. After removal of the blanking plug, an external and separate pilot oil return at zero pressure to the tank is, however, also possible here.</li> <li>2 Space required to remove the mating connector</li> <li>3 Name plate</li> <li>4 Maximum pressure limitation with version DREM and DREME</li> <li>5 Check valve, optional</li> <li>6 Locating pin</li> <li>7 Pilot oil return to the tank always external and at zero pressure</li> </ol> | <ol style="list-style-type: none"> <li>8 Blind counterbore</li> <li>9 Identical seal rings for ports A and B</li> <li>10 Identical seal rings for port Y and blind counterbore (item 8)</li> <li>11 Pressure gauge connection G 1/4; 12 deep</li> <li>12 Mating connector according to DIN EN 175301-803</li> <li>13 Mating connector according to DIN EN 175201-804</li> <li>14 Integrated electronics (OBE)</li> <li>15 Space required to remove the mating connector</li> <li>16 Cable fastening</li> </ol> |
|---|--|

Hexagon socket head cap screws (separate order)		Material number
Size 32	6x ISO 4762 - M10 x 70 - 10.9-fIZn-240h-L Friction coefficient $\mu_{\text{total}} = 0.09$ to $0.14$ ; tightening torque $M_A = 60$ Nm $\pm 10$ % or 6x ISO 4762 - M10 x 70 - 10.9 Friction coefficient $\mu_{\text{total}} = 0.12$ to $0.17$ ; tightening torque $M_A = 75$ Nm $\pm 10$ %	R900002245

**Notice:** For reasons of stability, exclusively these valve mounting screws may be used. The tightening torque of the hexagon socket head cap screws refers to the maximum operating pressure!

Subplates	Data sheet	Material number
Size 32	45062	

## Accessories

(not included in the scope of delivery)

External control for type DREM	Data sheet	Material number
VT-MSPA1-11-1X/ in modular design	30223	
VT-VSPD-2 in Euro-card format	30523	
VT-VSPA1-11-1X/ in Euro-card format	30100	
VT-SSPA1-1-1X/ as plug-in amplifier	30116	

Mating connectors (details see page 8)	Data sheet	Material number
For type DRE(M): Mating connectors according to DIN EN 175301-803	08006	R901017011
For type DRE(M)E: Mating connectors according to DIN EN 175201-804	08006	R900021267 (plastic) R900223890 (metal)

Bosch Rexroth AG  
Hydraulics  
Zum Eisengießer 1  
97816 Lohr am Main, Germany  
Phone +49 (0) 93 52 / 18-0  
documentation@boschrexroth.de  
www.boschrexroth.de

© This document, as well as the data, specifications and other information set forth in it, are the exclusive property of Bosch Rexroth AG. It may not be reproduced or given to third parties without its consent.  
The data specified above only serve to describe the product. No statements concerning a certain condition or suitability for a certain application can be derived from our information. The information given does not release the user from the obligation of own judgment and verification. It must be remembered that our products are subject to a natural process of wear and aging.